

MITEL 112 DECT PHONE (UNIVERSAL)

HANDSET USER GUIDE



NOTICE

The information contained in this document is believed to be accurate in all respects but is not warranted by Mitel Networks™ Corporation (MITEL®). The information is subject to change without notice and should not be construed in any way as a commitment by Mitel or any of its affiliates or subsidiaries. Mitel and its affiliates and subsidiaries assume no responsibility for any errors or omissions in this document. Revisions of this document or new editions of it may be issued to incorporate such changes.

No part of this document can be reproduced or transmitted in any form or by any means - electronic or mechanical - for any purpose without written permission from Mitel Networks Corporation.

TRADEMARKS

The Mitel word and logo are trademarks of Mitel Networks Corporation.

Other product names mentioned in this document may be trademarks of their respective companies and are hereby acknowledged.

Handset User Guide
Release 1.0 - January

®,™ Trademark of Mitel Networks Corporation
© Copyright 2016 Mitel Networks Corporation
All rights reserved

ABOUT THIS DOCUMENT	1
Audience.....	1
Abbreviations.....	1
MAKING HANDSET READY	2
Package - Contents/Damage Inspection	2
Before the Package Is Opened	2
Contents of the Package.....	2
Damage Inspection	3
Before Using the Phone.....	3
Installing the Batteries.....	3
Using the Charger	3
Handset in the Charger	3
To Open Back Cover.....	4
To Replace Battery.....	4
Handset Serial and IPEI Number	4
PHONE OVERVIEW	5
Handset – Front View	5
Rear View – Handset.....	6
DISPLAY	7
Icons and Text in the Display.....	7
Menu icons	8
Keys and Buttons.....	9
Navigation Keys/Selection Key	9
Softkeys.....	9
Off-hook Key	9
On-hook and On/Off Key.....	9
Speed Dial Keys.....	9
The Keypad	10
Idle Mode, and Number Input Mode.....	10
In Text Input Mode	10
Silent Mode from #-Key.....	10
BASIC OPERATION	11
to Switch Handset On/Off	11
Lock/Unlock the Keypad.....	11
Entering a Number in Idle	11

MENU OPERATION.....	12
Contacts.....	12
Add Contact	13
Call/Edit a Contact	13
More Contacts Options	13
Speed dial/One Touch Dial.....	14
Central Directory.....	15
LDAP Mode and Local Mode.....	16
Calling a Contact in the Central Directory	17
Calls.....	17
Call.....	18
View	19
More Calls Options	19
Connectivity	20
Register.....	20
Deregister	21
Select PBX.....	21
Settings.....	21
Time & Date	22
Language	23
LED Signal.....	24
Power Save.....	25
Security	25
Handset Name.....	26
Reset Settings.....	27
Status.....	27
Auto Answer.....	28
Silent Charging	28
Do Not Disturb	28
Hide Number.....	29
Call Forward.....	29
Idle Screen Saver	30
Idle Clock	31
Audio Settings	31
Silent Mode	31
Ring Volume and Ring Melody	32
Key Sound	33
Confirmation Sound	33
Coverage Warning.....	34
Charger Warning.....	34

CALL OPERATIONS 35

- Incoming call 35
 - Answering an Incoming Call 35
 - Reject an Incoming Call 35
 - Silencing an Incoming Call 36
 - Ending a Call 36
- Initiating a Call 36
 - Initiating a Call from Idle 36
 - Initiating a Call from Contacts 37
 - Initiating a Call from Calls 37
 - Initiating a Call from the Central Directory 37
- Call Holding/Retrieving 38
- Call Transfer 38
 - Supervised Transfer 38
 - UnSUPERVISED Transfer 39
- Swap between Two Calls 40
- Call Waiting 41
- Conference Call 41
 - Establishing a Conference Call 42
 - Terminating a Conference Call 43

TROUBLESHOOTING 44

- Operational problems 44

ABOUT THIS DOCUMENT

This document describes the features and functionalities provided by the Mitel 112 DECT Phone.

AUDIENCE

This guide is intended for users and system administrators.

ABBREVIATIONS

For the purpose of this document, the following abbreviations hold:

DECT:	Digital Enhanced Cordless Telecommunications
IPEI:	International Portable Equipment Identity
MAC:	Media Access Control
PBX:	Private Branch Exchange

MAKING HANDSET READY

This chapter describes how to prepare the handset for use, install, and how to insert and charge new batteries.

PACKAGE - CONTENTS/DAMAGE INSPECTION

BEFORE THE PACKAGE IS OPENED

Examine the shipping package for evidence of physical damage or mishandling prior to opening. If there is evidence of mishandling prior to opening, you must report it to the relevant support center of the regional representative or operator.

CONTENTS OF THE PACKAGE

Before proceeding, ensure that the handset unit package/box contains the following items:

- 1 x Charger with A/C Adaptor
- 2 x Battery, AAA
- 1 x Handset Unit, 1 x Battery cover

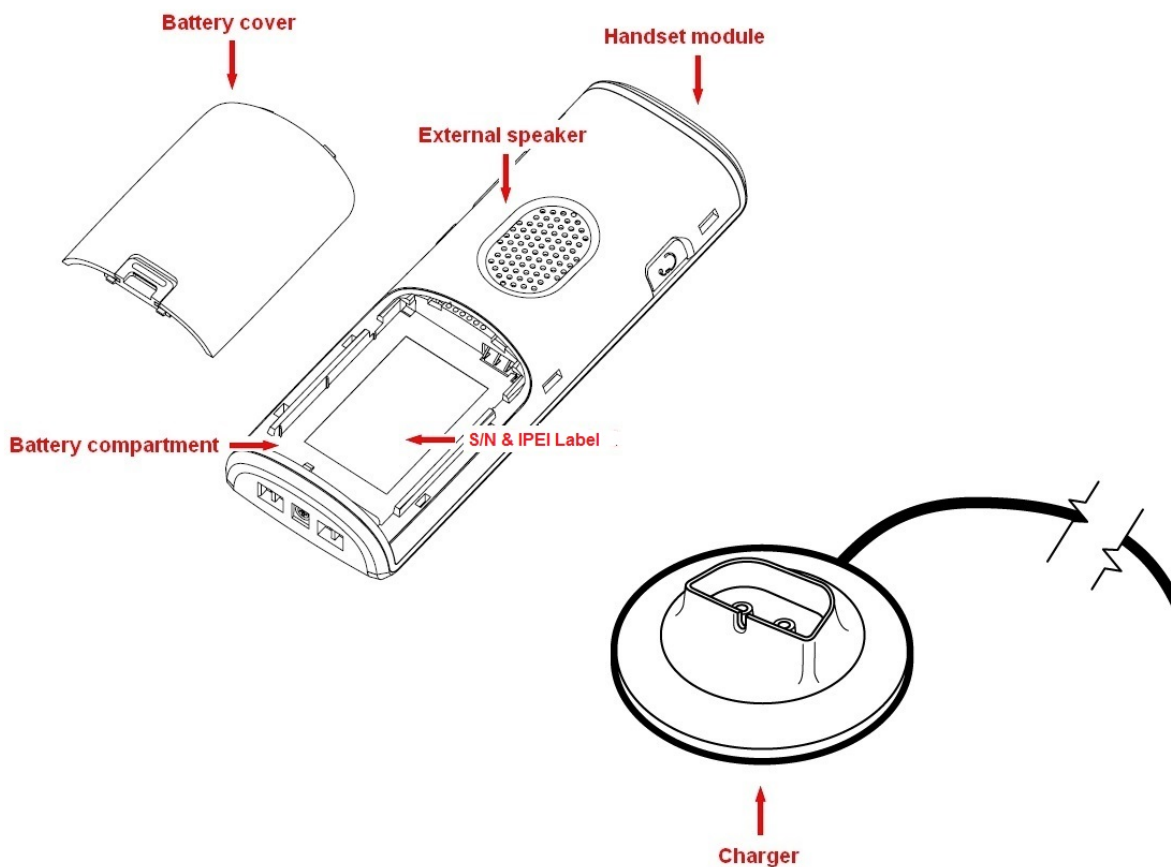

DAMAGE INSPECTION

1. Examine all relevant components for damage.
2. Make a “defective on arrival - DOA” report or RMA to the operator. Do not move the shipping carton until it has been examined by the operator. The operator/regional representative will initiate the necessary procedure to process this RMA. They will guide the network administrator on how to return the damaged package if necessary.
3. If no damage is found then unwrap all the components and dispose of empty package/carton(s) in accordance with country specific environmental regulations.

BEFORE USING THE PHONE

INSTALLING THE BATTERIES

This product uses Rechargeable Nickel Metal Hydride batteries. Only use the batteries that came with the handset or Mitel PN 51303917 replacements. Do not use any other type, since this may present a risk of leakage, fire, explosion or other hazardous situation.

1. Never dispose of a battery in fires; otherwise, it will explode.
2. Never replace the batteries in potentially explosive environments, for example close to flammable liquids or gases.
3. ONLY use approved batteries and chargers supplied by the vendor.
4. Do not disassemble, customize, or short circuit the battery

USING THE CHARGER

Each handset is charged through the use of a handset charger. The charger is a compact desktop unit designed to automatically charge and maintain the correct battery charge levels and voltage. The handset charger is powered by AC supply from 110-240VAC that supplies 5.5VDC at 600mA. When charging the battery for the first time, it is necessary to leave the handset in the charger for at least 10 hours before the battery is fully charged, and the handset is ready for use.

HANDSET IN THE CHARGER

For correct charging, ensure that the room temperature is between 0°C and 25°C / 32°F and 77°F. Do not place the handset in direct sunlight. The battery has a built-in heat sensor which will stop charging if the battery temperature is too high.

If the handset is turned off when placed in charger, the handset turns on and displays the message “The battery is charging”. After a while, the display backlight first dims and then turns off (unless demo mode is enabled). In this state, the handset will still respond to incoming calls.

If the handset is turned on when placed in charger, the display shows the message “The battery is charging”. After a while the display backlight first dims and then turns off unless “Idle Screen Saver” is switched on.

TO OPEN BACK COVER

1. Press down the back cover lock and lift the back cover away from the handset.
2. Remove the back cover from the handset.

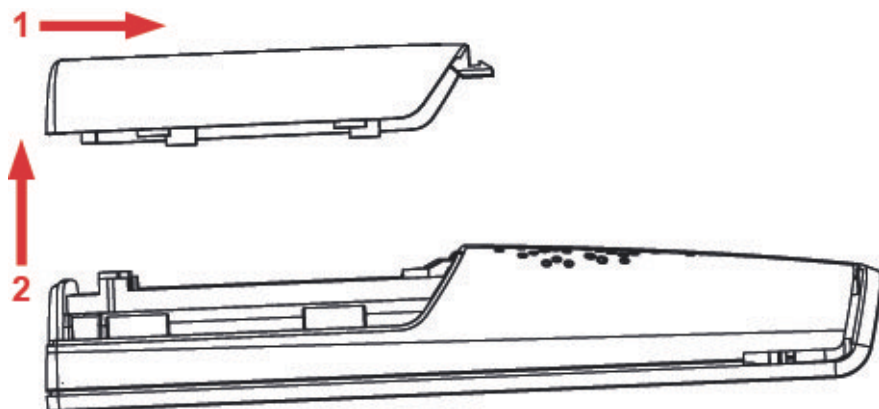

TO REPLACE BATTERY

Remove the back cover as shown above. Remove the old battery and replace it with a new one.

HANDSET SERIAL AND IPEI NUMBER

The serial number and IPEI number of each handset are found either on a label which is placed behind the battery, or on the packaging label. First, lift off the handset back cover, lift the battery, and read the serial number.

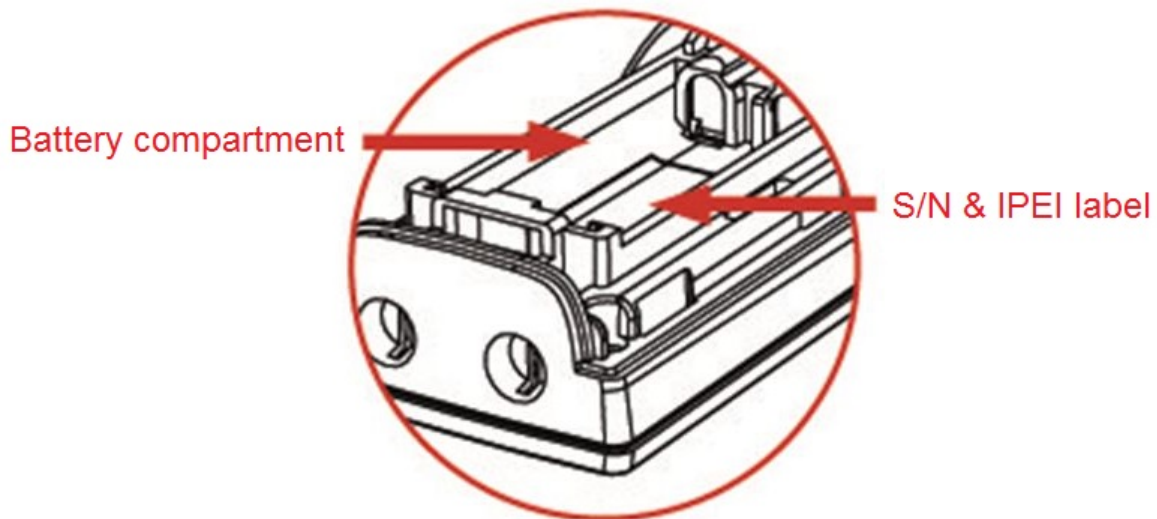

PHONE OVERVIEW

This section contains an overview of the handset from a front and a rear view.

HANDSET – FRONT VIEW

Earpiece Speaker

Screen

Navigation Keys (Up/Down/Right/left)

Selection Key (Centre of Navigation Keys)

This functions as the activity menu key. Press this in idle to enter all the menus available on the handset.

Call Key/ Accept Call Key (Off-hook key)

Press to answer a call, and it functions as a shortcut to the call list.

End, ON/OFF Key, Back Key (On-hook key)

Press to end call, to return to a previous menu, and to switch the handset on/off by long-press.

Right Softkey

Used for different commands; its function changes according to what is displayed on the screen.

Left Softkey

Used for different commands; its function changes according to what is displayed on the screen.

Numeric Keypad

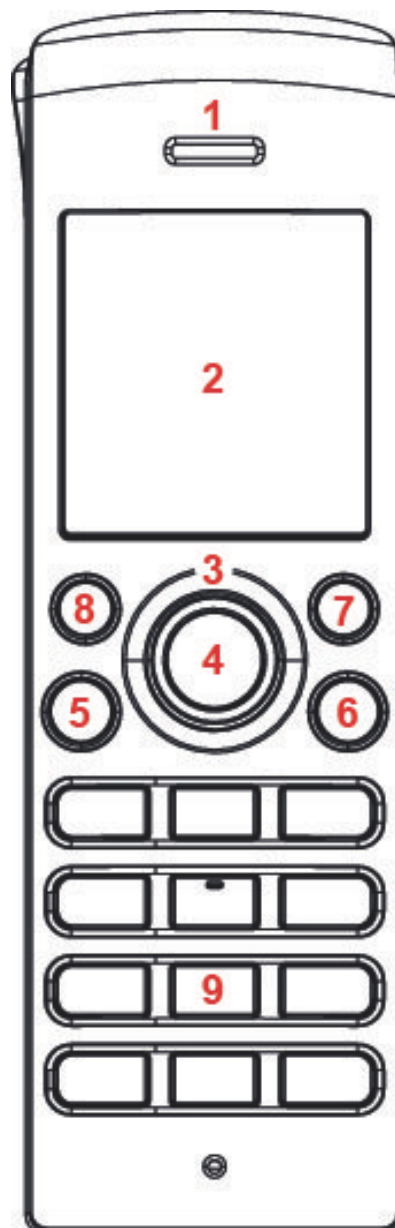

REAR VIEW – HANDSET

Headset connector (3.5mm)

This is for connecting a headset. The connector is protected against dust by the headset connector cover.

External Speaker

Is used for ringing, alarms, and when speaker mode is enabled in call.

Battery

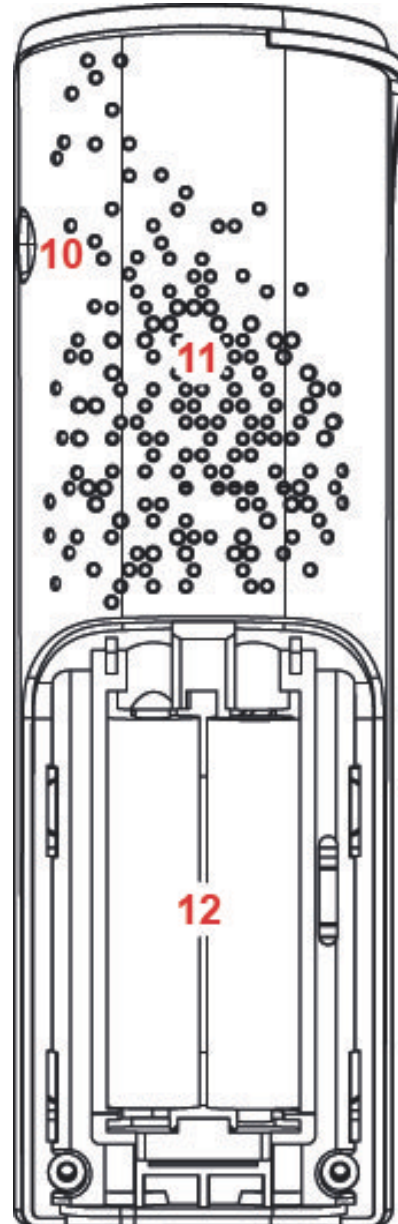

DISPLAY

This section contains a description of the different icons seen in the idle and in the menu.

ICONS AND TEXT IN THE DISPLAY

All available functions and settings are shown as icons and text in the display. The icons and text in the display indicate functions and settings to which you have access.

The picture below shows a typical idle screen that displays the time and date, display name (which is set on the web interface of the base station), registration number, and handset name which is set locally on the handset. This active area is also the area for a dialog window text if there has been a missed call, or if an action needs to be confirmed.

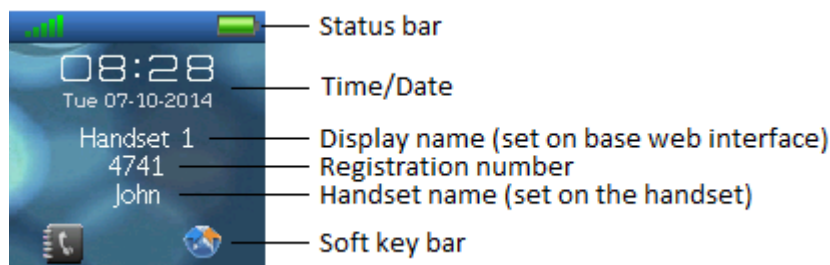

In the softkey bar at the bottom of the idle screen it is possible to access from the left: Contacts and Central Directory.

The status bar at the top of the idle screen is always visible in all screens. This displays icons which give the user information about signal strength, missed call, new voicemail message, phone lock, key lock, sound off, time, and battery status. These icons are shown and explained shortly in the following:

 "Signal strength" icon is always visible in the upper left corner. The number of green bars indicates the strength of the signal.

 "Battery" icon is always visible in the upper right corner, and shows how much battery is left on the handset.

 "Full battery" icon is displayed when the handset is fully charged.

 This battery icon is displayed when there is 20% to 32% battery left on the handset.

 "Low battery" icon is displayed when there is 10% to 20% battery left on the handset.

 "Missed call" icon is displayed in the status bar, and indicates that there has been a missed call which can be seen in the call list.

 "Voicemail message" icon is displayed in the status bar when there are voicemails that have not been listened to. This icon remains until the voicemail has been listened to.

 “Sound off”/“Silent” icon is displayed in the status bar when silent mode is enabled on the handset.

 “Keylock” icon indicates that the keypad is locked, and the user needs to long-press the * -key to be able to use the handset again.

 “Do not disturb” icon is displayed in the status bar when this feature is enabled; in this case the handset does not react on any incoming calls.

 “HD” icon is displayed during a call if the quality of the call is “High Definition” and hereby using the 722 codec (also called a wideband call).

MENU ICONS

All the menus available on the handset are displayed when the menu key is pressed from idle. The available menus are seen in the screen below.

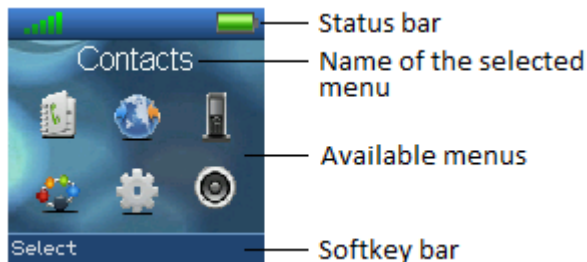

The status bar at the top of the display is always displayed independent of which menu is selected, and the softkey bar shows the possible options to select in every menu. In the active area of the screen the name of the selected menu is displayed at top, and the available menus to select are displayed. During navigation across the different menus the highlighted icon is moved to indicate that it is selected.



Contacts: contains all names/numbers in the local phonebook.



Central directory: contains all names/numbers in the central directory of the system. This is set up in the web interface of the base station system.



Calls: contains call lists and call times.



Connectivity: contains options to register or deregister the handset and network options.



Settings: contains personal handset settings such as time and date, language, handset name, and so forth.



Audio settings: contains personal handset settings for the audio profile such as ring volume, ring melody, and so forth.

KEYS AND BUTTONS

NAVIGATION KEYS/SELECTION KEY

Use this key to navigate in menus, and to move the cursor when you are entering text or

numbers. The navigation keys  allow you to step left/right and up/down when navigating in the menus. When you are selecting or entering a menu, use the selection key in the middle of the navigation keys. This key is also used to access the activity menu from idle. When you are on a call, the up and down keys adjust the volume and the left key enables or disables the mute function.

SOFTKEYS

The handset has two softkeys  located just beneath the display, and the function of each one is indicated by the prompt in the display just above each softkey according to the respective screen.

OFF-HOOK KEY

Press this key  to answer an incoming call, or dial a number either directly from the idle, or from the contact list, call list, or central directory. If you press this key from idle mode it opens the call list; pressing it during a call activates the speaker mode.

ON-HOOK AND ON/OFF KEY

Use the On-hook key  to disconnect calls, and return to the previous menus when navigating menus. A long-press of this key in idle mode turns the handset off, and a long-press when the handset is switched off turns the handset on.

SPEED DIAL KEYS

Any key from “2” – “9” can be set as a speed dial key. A long-press on any of these numbers when the handset is in idle can be set to a shortcut to calling any contact in the contact list, or in the F-Key list. For additional information, see *Speed dial/One Touch Dial*.

THE KEYPAD

Use the keypad to enter names or numbers. The figure below shows the available characters on the handset.

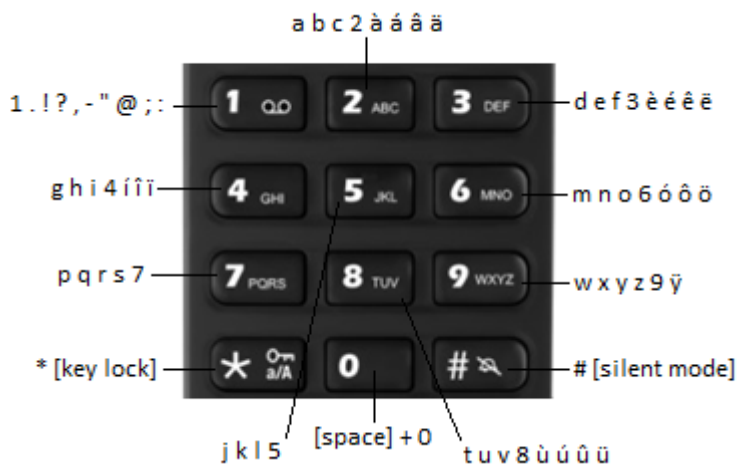

Note: Depending on the selected menu language, other characters can be available. Therefore, the character order can differ from the table above.

IDLE MODE, AND NUMBER INPUT MODE

When the handset is idle, a short press on a key enters the digits “0” – “9” and the characters * and #. In number input mode, a long-press on “0” generates a +.

IN TEXT INPUT MODE

While in text input mode a short press on a key 0-9 displays the first available character on that specific key. The marked character is then selected after a timeout, or when another key is pressed.

By pressing the *-key it is possible to change the text to be upper/lower case or only numeric (Abc, abc, ABC, or 123).

Use the 0 to add a space in the text.

SILENT MODE FROM #-KEY

By long-pressing the #-key when the handset is in idle, the handset is set to silent mode, and a “Sound Off” icon  is shown in the status bar. This feature allows you to turn on silent mode quickly. To turn off silent mode, you can long-press the #-key or enter the “Audio settings” menu and disable silent mode from the list.



Note: All audio settings, except the silent mode option, are disabled (greyed out) when the handset is in silent mode.

BASIC OPERATION

The following sections explain three basic operations of the handset: how to switch the handset on/off, how to lock/unlock the keypad, and the options available when you enter a number from idle mode.

TO SWITCH HANDSET ON/OFF

Switching on the handset

To switch the handset on, long-press the  key. When the handset is on, it displays “Searching” for a short while until a signal is detected. The handset then displays the registration number and is ready for use.



Switching off the handset

To switch the handset off, return to the idle screen and long-press the  key and the handset will turn off.

LOCK/UNLOCK THE KEYPAD

To prevent accidentally calls, you can lock the keypad.

Locking the keypad

To lock the keypad long-press the  in idle. The following text message is displayed: “Press and hold *”. When the keypad is locked, the “Key Lock” icon  is displayed in the status bar.

Unlocking the keypad

To unlock the keypad long-press  until the text message “Press and hold *” disappears.



Note: It is possible to answer or reject an incoming call while the keypad is locked.

ENTERING A NUMBER IN IDLE

When entering a number in idle it is possible to call the number by pressing the  key. Otherwise, the following two different options are available when a number is entered in idle.

Save

Press the Save softkey to add the number as a local contact.

Clear

Press the “Clear” softkey to delete one character at a time to the left of the cursor.

MENU OPERATION

This section describes the different menus and submenus on the handset.

From idle mode, you can enter some menus directly via the two softkeys as displayed on the image below. Press the left softkey to enter the Contacts menu, press the right softkey to enter the Central Directory menu.



To enter the menu from idle mode, press the selection key in the middle of the navigation keys :



CONTACTS

All the local contacts on the handset are displayed in the Contacts menu. Below both a full and an empty local phonebook are displayed.

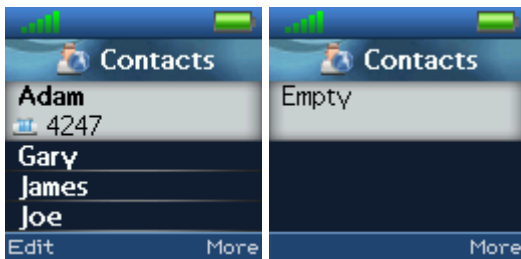

ADD CONTACT

To add a new contact press “More”, select “Add contact” and the information displayed in the menu tree below can be filled out for the contact.

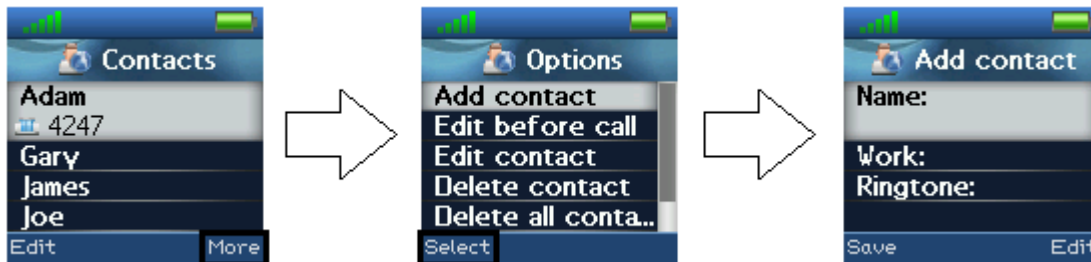

Hereby, it is possible to edit the name, add a work phone number, and add a specific ringtone to be used for this contact.

To save a new contact, press the “Save” softkey.

CALL/EDIT A CONTACT

When the “Contacts” menu contains contacts it is possible to edit each contact with the left softkey. When pressing “Edit” it is possible to edit the name, work, or ringtone for the highlighted contact.



To call a contact, scroll to the contact and when the contact is highlighted, press the green off-hook key .

MORE CONTACTS OPTIONS

When a specific contact is highlighted, pressing “More” in the “Contacts” menu enables the features seen below.



Edit before call

This function allows you to edit the number of the contact before calling the contact.

Edit contact

This has the same function as pressing “Edit” directly from the “Contacts” menu, and allows you to edit the name, work, mobile, home, other, or ringtone for the contact.

Delete contact

After you select this feature, the following text message is displayed: “Delete current contact from local contact list?”

To delete the selected contact press the “Yes” softkey.
To go back to the “More” menu, press the “No” softkey.

Delete all contacts

This function allows you to delete all the contacts in the local contact list

To delete all contacts in the local contact list, press the “Yes” softkey.
To go back to the “More” menu, press the “No” softkey.

SPEED DIAL/ONE TOUCH DIAL

Use this feature to add a contact to the speed dial. After you add the contact to the speed dial, it can be dialled directly from idle by long-pressing the contact’s speed dial number. The speed dial feature allows the user to assign a speed dial number (2 – 9) to a contact. This enables the user to call a contact by making a single long-press on one of the number keys (2 – 9) when in idle.

A contact can only be assigned to one speed dial number at a time. The first defined number of the contact will be dialed when the speed dial key is pressed. This means that if all numbers (work, mobile, home, and other) are defined for the contact then the work number will be dialed. If the work number is not defined then the mobile number is dialed etc.



Note: The ‘1’ key is reserved for voicemail. Long key press on ‘0’ is used for starting a normal dial string with ‘+’.

To setup speed dial

Prerequisite: There must be at least one contact in the contact list.

Steps:

1. Go to the contact list > scroll to the contact that you want to assign a speed dial number to.
2. Select “More” > select “Speed dial”
3. Move to the speed dial number (2 – 9) that you want to assign the contact number to.
4. Select “Add”. The contact name should be appended to the speed dial number.
5. Leave the speed dial list by pressing the red “On-hook” key. Press the “On-hook” key to exit “More” menu, and exit the contacts list by pressing “On-hook” key again.

The images below illustrate how to add local contact 'Adam' as a speed dial number to 2.

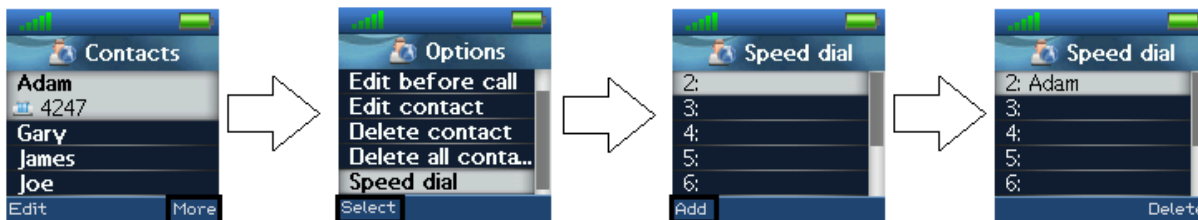

To call a speed dial number

Prerequisite: The handset is in idle and the key lock is not active.

Steps:

- 1. Make a long key press (> 2 seconds) on a speed dial key that is assigned to a contact. The first number defined is dialed.

For example, local contact 'Adam' is called directly from idle by long-pressing 

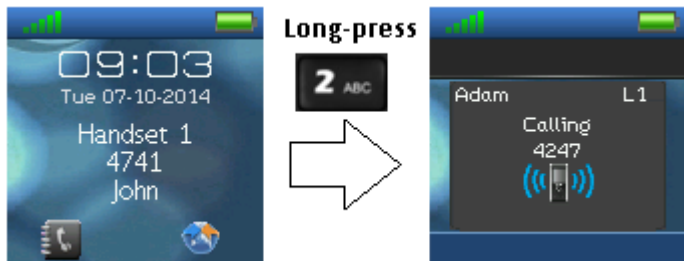

CENTRAL DIRECTORY

The "Central directory" menu provides a different list of contacts that your system administrator has configured in the base system. From idle mode, press the right softkey  to enter the Central directory.



Otherwise, you can open the menu by pressing the selection key  from idle mode and then choosing "Central directory".



LDAP MODE AND LOCAL MODE

You can set the “Central directory” to LDAP Mode or Local Mode via the web interface of the base station (see [2] for additional information on this).

When you set the directory to LDAP mode, opening the central directory displays a search screen as shown below. If you leave the search field empty and press the “Search” softkey, all the contacts in the central directory are displayed.

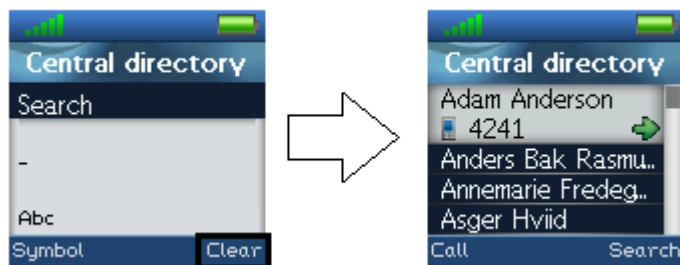

Note: When the central directory is in LDAP mode if you press the “Search” softkey, the handset will return to the “Search” field and you can perform a new search for a. If you press the red “On-hook” button in the central directory, the handset returns to idle.

If the central directory (instead of LDAP mode) is set to Local mode, opening the central directory takes you directly to browsing mode. To enter search mode, press the “Search” softkey as displayed below.



The search function is similar in these two modes. If you type a name in the search field and then press Search, the search results are displayed.

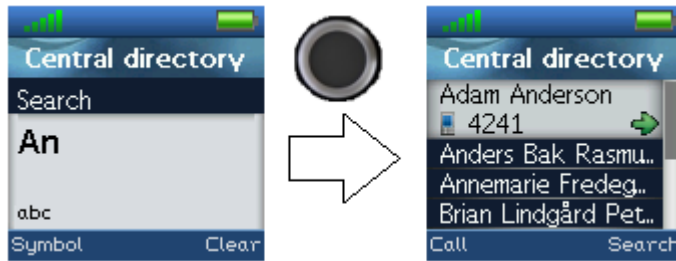

To scroll through the search results, use the up and down navigation keys. If a green arrow is displayed to the right of a contact (as seen above), this contact has more than one number assigned. To scroll through these different numbers, use the left and right navigation keys.

CALLING A CONTACT IN THE CENTRAL DIRECTORY

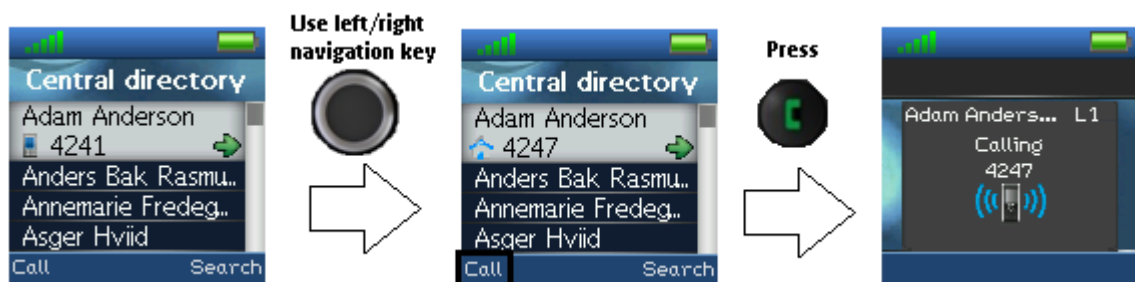

To call a contact from the central directory, press the green “Off-hook” button. The contact number that is currently displayed on the screen is called.



If a contact has more numbers assigned, a green arrow is shown to the right of the contact. Press the right and left navigation keys to navigate between the different numbers assigned to that contact. The number that currently appears on the screen is the one that is called.

CALLS

The menu “Calls” is a list of all the calls that have been made to or from the handset.

Enter this menu by pressing the green off-hook button , or from the menu by pressing the selection key  and choosing “Calls”.



Use the up/down navigation keys  to scroll through the list. The list contains all the different call types (including both outgoing and incoming) that have been made to or from the handset.

If there is a missed call on the handset, a red icon  is displayed in the status bar until the entry has been viewed in the “All calls” list. As shown in the images below, the information displayed about the missed call in the call list is in bold text until the entry has been scrolled over once.



After the entry has been displayed once, the call information text is no longer bold and the red missed call icon disappears from the status bar.

CALL

To initiate a call directly from the local call list, use the up and down navigation keys to

highlight an entry and press the green off-hook button . This action initiates a call to the highlighted entry. For example:



VIEW

The left softkey enters a “View” function for each entry. With this feature the following details of the call can be seen: number, status (answered, dialled, missed), duration, and time stamp as displayed in the image below.



MORE CALLS OPTIONS

When a specific call is highlighted, pressing “More” in the “Calls” menu opens the “Options” submenu below.



View details

This shows the same details about the call as the “View” function explained in *Call/View*.

Save as contact

With this feature it is possible to save the number in the call list as a contact.

Append to contact

This function makes it possible to add the number in the call list to an existing contact.

Edit before call

With this function the number in the call list can be edited before calling.

Delete item

By selecting “Delete item” the following text message is displayed: “Delete current item from list?”

To delete the item from the call list, press the “Yes” softkey.
To return to the call list, press the “No” softkey.

Delete all items

This feature makes it possible to delete all items in the specific call list. By selecting “Delete all items” the following text message is displayed: “Delete all items in this list?”

To delete all items in the specific list, press the “Yes” softkey.
To return to the call list, press the “No” softkey.

CONNECTIVITY

The “Connectivity” menu is entered in the menu by pressing the selection key  in idle and choosing this menu.



In this menu it is possible to register or deregister the handset to a certain base system.

REGISTER

When a handset is to be registered on a base system, the user will be prompted for an access code (base registration Access PIN Code) before the registration procedure is started.

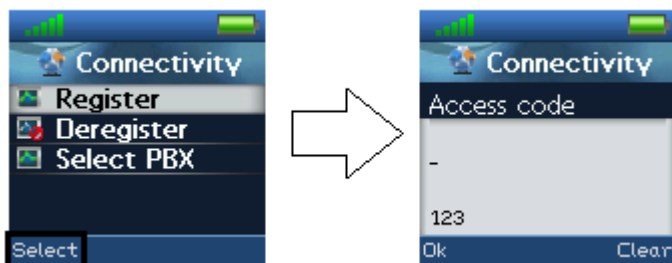

The Access PIN Code defaults to “0000” and cannot be changed via the handset. The access PIN code can only be changed via the web interface on the base. Refer to the System Guide for instructions on how to register a handset with a base system.

DEREGISTER

You can deregister a handset the base station. When deregistering a handset, you are prompted to enter the Access PIN Code (base deregistration PIN). The Access PIN Code defaults to “0000” and cannot be changed via the handset.

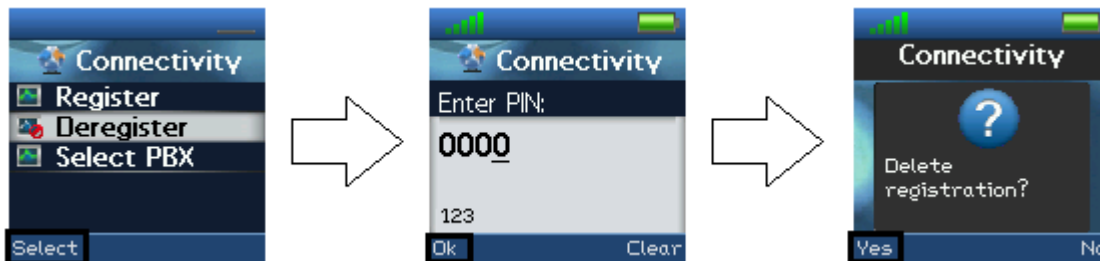

After deregistered is selected, a warning message “Delete registration?” is displayed as seen above. Accept the deletion by pressing “Yes”. The “No” cancels the operation.

SELECT PBX

In the “Select PBX” menu it is possible to select another PBX for the handset to use.



With this feature it is possible to connect the handset to another PBX than the one used by the base station system. In this way, the handset can function on a PBX without being connected to a system of base stations.

SETTINGS

The “Settings” menu is entered through the menu by pressing the selection key  in idle.



The “Settings” menu contains the following personal handset settings:

Settings

- Time & Date

- Language

- LED Signal

- Power save

- Security

- Handset name

- Line

- Reset settings

- Status

- Auto answer

- Silent charging

- Do not disturb

- Hide Number

- Call Forward

- Idle Screen Saver

- Idle Clock

TIME & DATE

To set the time and date in the handset select the “Time & date” menu. Change the time and date as shown below.



To change the time use the keypad, or the navigation keys to set the time to be what you want, and press **Save**, as shown in the third image. The time format can also be changed by pressing the **Format** softkey. In “Time format” the preferred time format (24 or 12 hours) can be selected.

In the same way the date can be changed as shown in the images below:

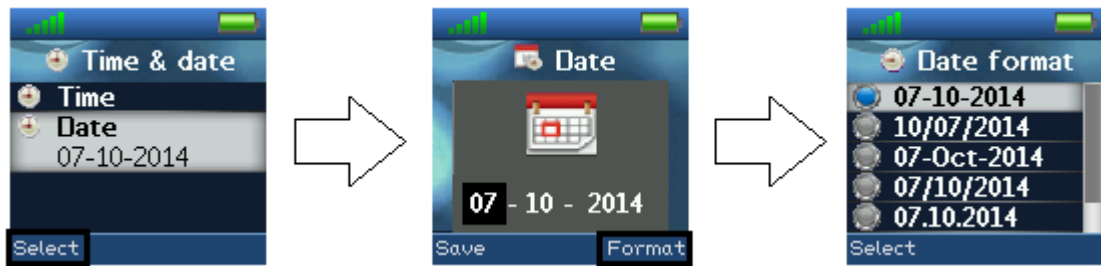

In “Date format” the preferred date format (for example: dd-mm-yyyy) can be selected by using the up and down navigation keys.

LANGUAGE

In this menu it is possible to select between different languages for the handset. The menu tree below shows the different languages available on the handset.

Settings

Language

English

Español

Deutsch

Français

Italiano

Nederlands

Português

Dansk

Svenska

Türkçe

Polski

Norsk

Russian-1

Russian-2

Hrvatski

Srpski

Slovenian

The currently applied language is displayed when highlighting or selecting the menu “Language”.

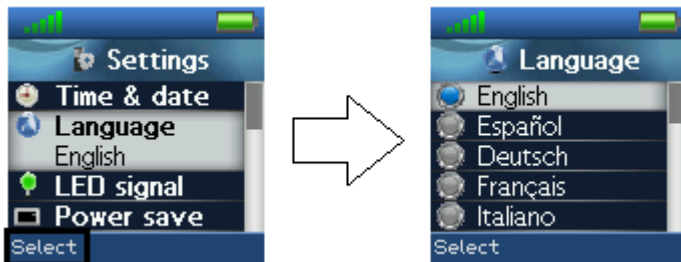

After entering this menu, you can select a specific language pressing the “Select” softkey. Scroll through the list using the up and down navigation keys.

LED SIGNAL

The LED at the upper left of the handset blinks green and can be assigned to distinctive situations by the user.



The green LED can be configured to blink at the following events:

Missed call

The green LED signal blinks when there is a missed call.

Voice message

The green LED signal blinks if there is a voice mail message that has not been listened to.

Low battery

The green LED signal blinks when the battery is low (below 20% battery on the handset).

Off

The LED signal is disabled, and does not blink in any situation.

POWER SAVE

The power save option prolongs battery life by turning off the display after a specified amount of time.



The images above illustrate how the power save can be set between 5 seconds and 60 seconds. An interval is chosen by pressing “Select” when the desired item is highlighted.

SECURITY

In the “Security” menu it is possible to set an automatic keylock and change the PIN of the handset.

Automatic keylock

If the “Automatic keylock” feature is enabled, the keypad locks automatically after a specified length of time during which the handset has not been used. The currently applied setting is displayed when you select the “Automatic keylock”



A list of selectable timeouts is displayed when the user enters the “Automatic keylock” menu. Choose a setting by pressing the “Select”. Afterwards, when the handset has been inactive in the selected time interval, the keypad will lock automatically.



Note: You cannot use the keys when Automatic Keylock is enabled. You must first unlock the keys by long-pressing . However, emergency numbers (for example, 911) can be called without having to unlock the keypad.

Change Handset Security PIN

“Change PIN” allows you to change the code. An example is show below.

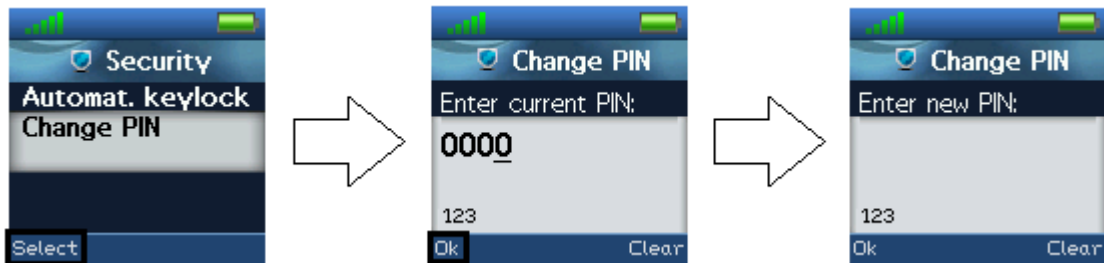

The current PIN code must be entered first to change it to a new PIN code.

HANDSET NAME

Handset name

By selecting “Handset name” the name of the handset can be changed.



An editor is displayed when entering the menu. The handset name is typed in using the numeric keys and afterward pressing the selection key to save the name. The handset name is displayed in the third line of the idle display.

Line

If the handset is used in a multiline environment, it is possible to select preferred lines for the handset to make outgoing calls from in the “Line” menu.



Note: To see additional information on this “Line” feature, please check the base system document via [2]

RESET SETTINGS

The handset settings can be reset to default settings by selecting this menu “Reset settings”.

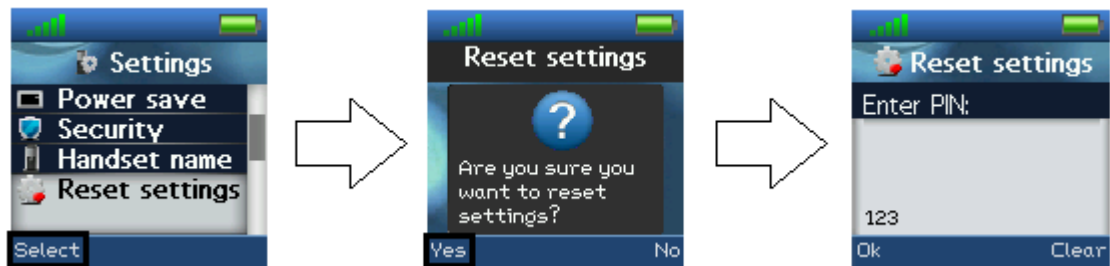

The handset PIN code is required to reset the handset. Following a reset, the handset is still registered because the base is not reset to default when you select this feature.

STATUS

The menu “Status” provides useful information about the handset and the handset’s base station.

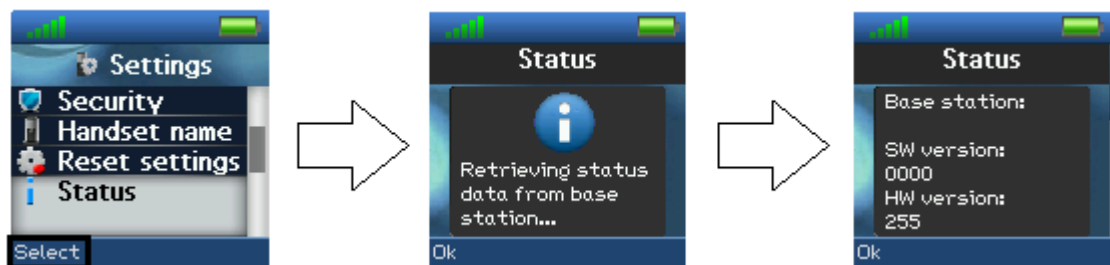

The displayed information is as follows.

Base station:

- Software version of the base station
- Hardware version of the base station
- IP address of the base station
- MAC address of the base station
- System name of the base stations to which the handset is registered

Handset status:

- Software version of the handset
- Hardware version of the handset
- DECT band in use, for example. EU or US
- Battery level of the handset
- IPEI is a unique, static number that identifies this handset

AUTO ANSWER

The “Auto answer” feature makes it possible for the handset to automatically answer an incoming call. This setting can be set to the following conditions:



- **Normal:** With this enabled the handset does not answer a call automatically, but the user must always press the green “Off-hook” key to answer a call. The call is not answered by removing the handset from the charger.
- **Any key:** In this mode pressing any key on the keypad (except the red “On-hook” key and the two softkeys that still have their normal functions) will answer an incoming call. The call is not answered by removing the handset from the charger.
- **Automatic:** If the feature “Automatic” is enabled on the handset, then the incoming call is answered automatically after 5 seconds.

SILENT CHARGING

The “Silent charging” feature can be used to disable ringing during charging. The options are as follows:



- **Off:** The handset is ringing when receiving incoming calls (audio alert and incoming call screen displayed).
- **Silent:** The handset receives an incoming call as normal, but it does not ring (i.e. no audio alert but the incoming call screen is displayed).

DO NOT DISTURB

Enable the “Do not disturb” feature when you do not want to be disturbed by calls.



If this feature is enabled, the handset will not respond to incoming calls. The “Do not disturb” icon  is displayed in the status bar when “Do not disturb” is enabled..

HIDE NUMBER

The “Hide Number” feature allows you to make calls such that the called party cannot see your caller ID.



- **Off:** When the “Hide Number” function is set to “Off” with the left softkey, the caller ID of the handset is displayed to the counterpart of the call.
- **On for next call:** If this function is enabled, the caller ID will be hidden for the counterpart only for the next outgoing call and displayed again for all following calls.
- **Always on:** With “Always on” enabled, the caller ID is hidden from the called party for all outgoing calls.



Note: When “Hide Number” is enabled, the base sends SIP header “Privacy: id” to address sip:anonymous@anonymous.invalid
The PBX must support anonymous calls; otherwise, the call is rejected.

CALL FORWARD

The “Call Forward” feature enables the user to forward all incoming calls in different cases as described below.



Forward Unconditionally

If this feature is enabled, all incoming calls to the handset will be forwarded to the number setup in “Forward To” as seen below.

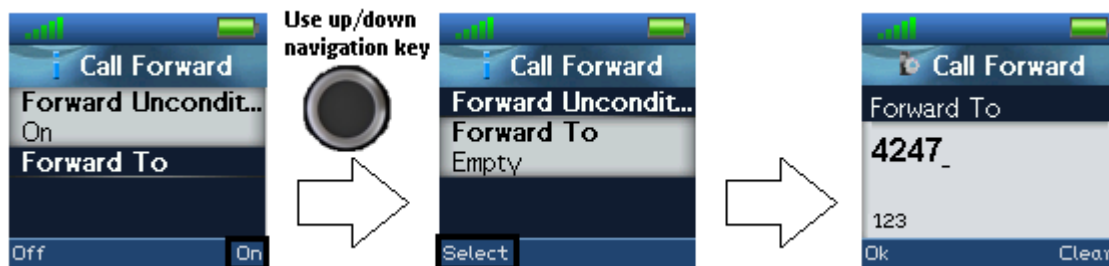

In this case the handset will not receive any incoming calls – all calls will automatically be forwarded to the number setup in “Forward To”.

Forward No Answer

By enabling “Forward No Answer”, an incoming call to the handset is forwarded if the call is not answered within a given time interval, for example 30 seconds. This feature is setup in the same way as “Forward Unconditionally” as displayed above.

Forward Busy

When “Forward Busy” is enabled, the handset forwards all incoming calls if the handset is busy, or if the user presses “Reject” on the call. This feature is also setup in the same way as “Forward Unconditionally” above.

IDLE SCREEN SAVER

When the idle screen saver is enabled, the handset screen will dim, but never turn off when the handset is placed in the charger.



The following three options can be selected for “Idle Screen Saver”:

- **Off:** The screen will turn off completely after the power save timeout, even with the handset placed in the charger.
- **Idle clock (dimmed):** The handset will return to the idle screen and the screen will be dimmed after the power save timeout when the handset is placed in the charger.
- **Startup image (dimmed):** The screen will be dimmed and display the startup image after the power save timeout when the handset is placed in the charger.

IDLE CLOCK

The “Idle Clock” function controls if the clock is showed in the idle display or not.



By selecting “Off” the idle clock will not be displayed in idle, and by selecting “On” the clock is displayed in idle.

AUDIO SETTINGS

The “Audio Settings” menu is entered through the menu by pressing the selection key  in idle. It contains different settings for the sounds and ringing on the handset.



SILENT MODE

The “Silent” profile can either be enabled with the “On” softkey or disabled with the “Off” softkey. When the “Silent” profile is enabled, no sounds are played on the handset and the handset does not ring on incoming calls or messages.



In the “Audio settings” menu no other settings can be entered when “Silent” is set to “On”.

RING VOLUME AND RING MELODY

When the handset receives an incoming call, different ring volumes and melodies can be selected.

Ring volume

The ring volume can be adjusted from mute to volume 6. The currently applied level is displayed when entering the menu “Ring volume”.

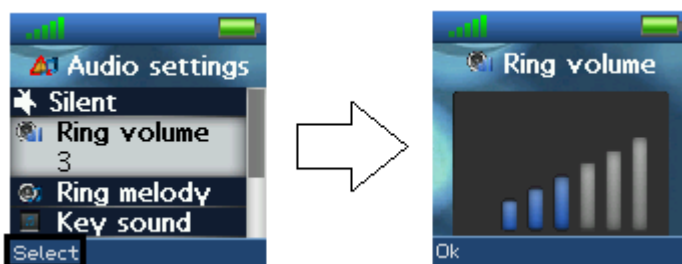

To select the desired ring volume, the navigation keys up/down or right/left are used to respectively increase or decrease the volume. Pressing “Ok” saves the current ring volume. The currently applied ring melody is played when adjusting the ring volume so that the respective ring volume can be heard before selected.

Ringer mute

The ringer is switched off when the lowest level is selected in “Ring volume”, and a mute image is shown in the display as seen below.

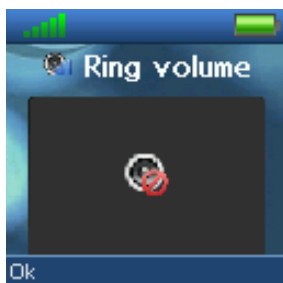

When the ring volume is set to mute, the “Sound off” icon is displayed in the status bar and no sound is heard when receiving an incoming call.

Ring melody

Six different ring melodies can be chosen for the handset to play when receiving an incoming call. A list of melodies is displayed when entering the menu. Each displayed melody on the list can be selected by pressing the “Select” softkey.



To hear the melody before selecting it, each melody in the list can be played by selecting “Play”. “Play” changes to “Stop” during playback and the playback can then be stopped by pressing this button.

KEY SOUND

The “Key Sound” settings controls whether or not a sound is made when you press handset keys. Three options are available:



Note: No key sound is generated when pressing the keys during “key lock state” even though one of the options “Click” or “Tone” is enabled.

CONFIRMATION SOUND

This feature can either enable or disable confirmation sounds on the handset.

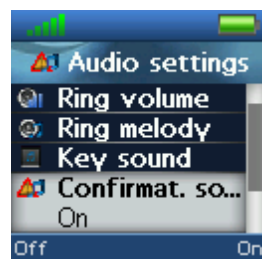

When the function “Confirmation sound” is enabled (On), an audible indication is given when an event succeeds or fails.

For example, a positive confirmation sound is generated when a new setting is set or an entry is saved successfully in the phonebook. A negative confirmation sound is generated if the action fails.

When the confirmation sound is set to “Off” no sounds is generated in either case.

COVERAGE WARNING

A coverage warning can be set to occur when the handset is out of range of a base station in the system.

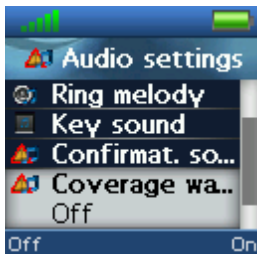

When the feature “Coverage warning” is enabled (On), an audible indication is given in the earpiece of the handset when the user is close to the maximum range of the nearest base station in the system. This way the user will know that the call is at the edge of the possible coverage of the call and that the user has to move back in coverage to keep the call going.



Note: This feature is only functions when the handset is in a call, not during idle mode.

CHARGER WARNING

This feature causes the handset to make a sound when you put it in the charger that indicates that the handset is charging.

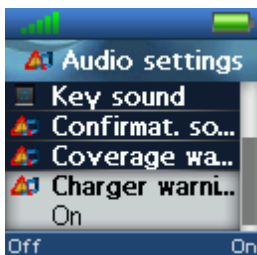

When the feature “Charger warning” is enabled (On), an audible indication is made when the handset is correctly connected to the charger. If the feature is set to “Off”, no audible indication is given when the handset is placed in the charger.

CALL OPERATIONS

This section describes call handling.

INCOMING CALL

As the handset receives an incoming call an alerting screen will be displayed as displayed below. This will be accompanied by a ring signal according to the respective settings on the handset.

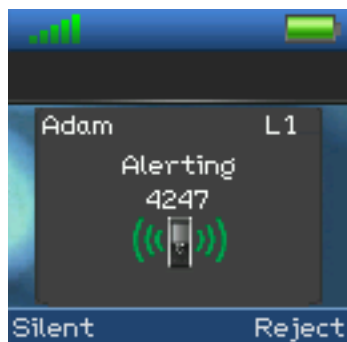

The calling party's handset number will be shown in the display, and an additional name is displayed if the calling party's handset number is stored in the local phonebook.

ANSWERING AN INCOMING CALL

To answer an incoming call press the green "Off-hook" button , or press the "Off-hook" button two times to change to speaker mode.



Note: When "Auto answer" is set to "Automatic" an incoming call is answered automatically after one ring signal. If "Auto answer" is set to "Any key" an incoming call can be answered by pressing any key on the keypad, and not just the green "Off-hook" button.

REJECT AN INCOMING CALL

It is possible to reject an incoming call by pressing the "Reject" softkey when you receive an incoming call. This way the calling party will receive a busy tone, and "User busy" displayed on the screen as shown in the picture below.

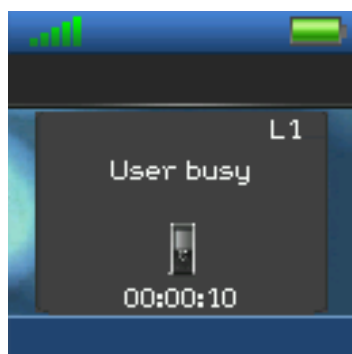

Note: An incoming call can also be rejected by pressing the red "On-hook" key.

SILENCING AN INCOMING CALL

When the handset is alerting, press the “Silent” softkey to stop the ringing. The handset will continue to alert, but without any ringing.

ENDING A CALL

To end an ongoing call press the red “On-hook” key , and the call is terminated. The duration of the call is shown in the display. Furthermore, this duration time can also be viewed from the call list where the call is stored.



Note: If one call is active and another call is on hold, then the active call is terminated when pressing the red “On-hook” button and the handset automatically returns to the call on hold. The call on hold is now active and the user has to press the red “On-hook” button again to terminate this call.

INITIATING A CALL

A call can be initiated from different locations on the handset:

- By entering the number directly from idle
- From the “Contacts” menu
- From the “Calls” menu
- From the “Central Directory”

How to initiate a call from these different directories is explained in the following sub sections.

INITIATING A CALL FROM IDLE

To initiate a call from idle:

1. Enter the number of the person you want to call when the handset is in idle.
2. Press the green “Off-hook” button  to call the number.



3. The handset displays the “Calling” screen as shown above.
4. When the called party answers the call, the screen shows “Connected” and the two parties are now in call.

Line Call

If the handset is used in a multiline environment, it is possible to make a call from different lines. The line must be predefined via the settings menu. Refer to the settings section of this guide.



Note: To see additional information on the “Line” function, please check the base system document via [2].

INITIATING A CALL FROM CONTACTS

To initiate a call from the contact list, there has to be contacts added to the local phonebook. When this prerequisite is met a local contact can be called by highlighting the contact in the contact list and then pressing the green “Off-hook” button.



Note: The list of local contacts can be reached from the menu “Contacts” or directly from idle by pressing the left softkey when in idle.

INITIATING A CALL FROM CALLS

The number of an outgoing, incoming or missed call can be called directly from the call list by highlighting the number and pressing the green “Off-hook” button to call the entry.



Note: The “Calls” list can be reached from the menu “Calls” or directly from idle by pressing the green “Off-hook” button.

INITIATING A CALL FROM THE CENTRAL DIRECTORY

When opening the “Central directory” a call can be made to a specific contact by searching for this contact, and thereby enter the list from which a contact can be called by pressing the green “Off-hook” key.

If different numbers are assigned to one contact, a green arrow is showed to the right of the contact, and the right/left navigation keys can be used to choose which number that should be called.



Note: The “Central Directory” can be reached both from the menu “Central Directory” or directly from the idle by pressing the right softkey when in idle.

CALL HOLDING/RETRIEVING

It is possible to hold a call which means that the one party of the call is put on hold and cannot hear the other party, but can only hear a repeated short tone on hold until the call is retrieved.

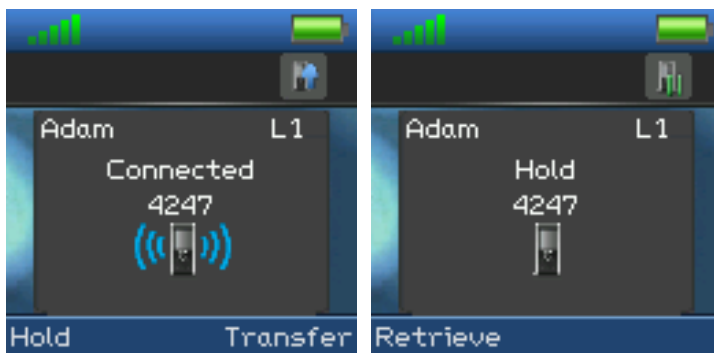

1. To put the called party on hold, press the “Hold” softkey and this party is put on hold.
2. To retrieve the call, and thereby continue the conversation, press the “Retrieve” softkey which is only showed on the screen when the other party of the call is put on hold.



Notes:

1. If one call is active and another call is on hold, then the active call will be terminated when pressing the red “On-hook” button, and the handsets automatically returns to the call on hold, i.e. the call on hold is now active, and the user has to press the red “On-hook” button again to terminate this call.
2. When the counterpart is put on hold it is also possible establish a second call and make a conference, swap or transfer which will be explained in the following sections.

CALL TRANSFER

When in an ongoing call, it is possible for either party to transfer the call, either supervised or unsupervised, to another handset.

SUPERVISED TRANSFER

For a supervised transfer you call the party to which the call is transferred, before you perform the transfer.

1. Initiate a call with a party so that the handset displays “Connected” as shown below.



2. Press “Transfer” on either of the handsets in call. The counterpart of the call is put on hold.
3. Enter the number that the transfer should be made to and press the green “Off-hook” button

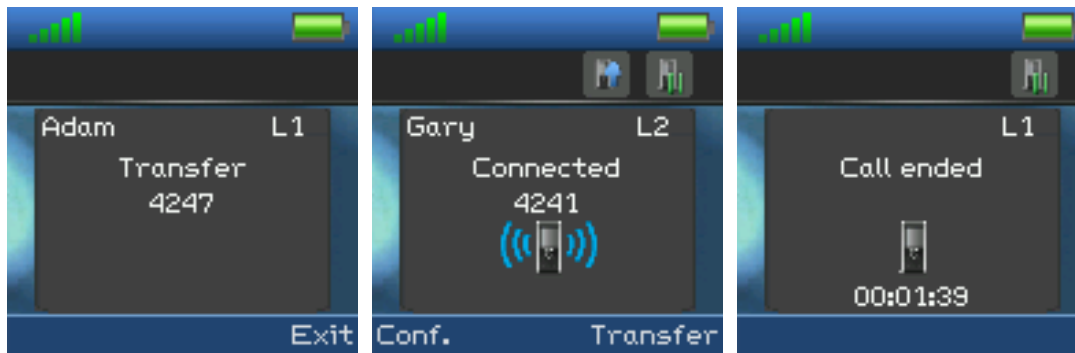

4. A ring back tone is heard and the third party is called.
5. As the third party answers the call, the handset initiating the transfer will show a connected screen as seen above.
 - To make the transfer after the third party has answered the call, press “Transfer”. The call is transferred so that the second and third party are now in call and a “Call ended” screen is displayed on the handset that initiated the transfer as seen above.



Note: It is also possible to make an supervised transfer by pressing either the “Hold” softkey instead of pressing “Transfer” in step 2.

UNSUPERVISED TRANSFER

When making an unsupervised transfer, the call will be transferred directly to a third party without the party initiating the transfer needing to call this third party before the transfer.

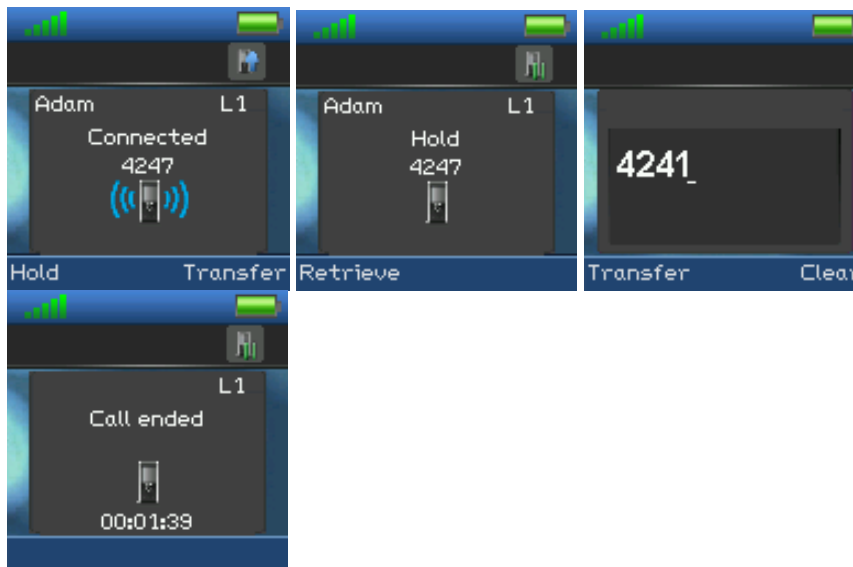

1. Initiate a call with a counterpart so that the handset displays “Connected” as shown above.

2. Press the “Transfer” softkey on either of the handsets in call, and the counterpart of the call is put on hold.
3. Enter the number that the transfer should be made to, and press transfer.
4. This will end the call on the first handset party (screen showing “Call ended”), and the second party will stop being on hold and hear a ringback tone instead which indicates that this handset is now calling the third party.
5. When the third party answers the call an unsupervised transfer has been made and the second and third party are now in call.



Note: As with supervised transfer, it is also possible to make an unsupervised transfer by pressing “Hold” instead of pressing “Transfer” in step 2.

SWAP BETWEEN TWO CALLS

It is possible to swap between two calls. In this case, one party will be in ongoing call, and the second party will be on hold. So “Swap” means that it is possible to toggle between these two parties.



1. Initiate a call with a counterpart so that the handset displays “Connected” as shown above.
2. Put this call on hold by pressing the “Hold” softkey.
3. Enter the number of a second party, and press the green “Off-hook” button.
4. A ring back tone is now heard in the handset as the second party is alerting.

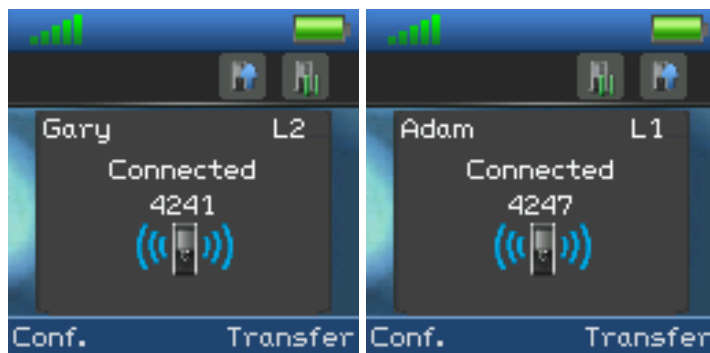

5. As the second party answers the call a blue “Connected” screen as above is displayed.
6. By pressing the right navigation key , the two calls are swapped which means that the ongoing call is now between the first party with the second party now put on hold.

7. From this point, it is possible to toggle between the two parties by pressing the right navigation key. For each time that the right navigation key is pressed a toggle is made between the two external parties, and the small handset icons in the right top corner of the display and either "L1" or "L2" shows if the handset is connected to the first or the second party.

CALL WAITING

When two parties are in call a third party can call one of the two parties and leave a Call Waiting signal. During a call waiting, two short beeps are heard every three seconds in the handset receiving the call waiting and the following screen is displayed:

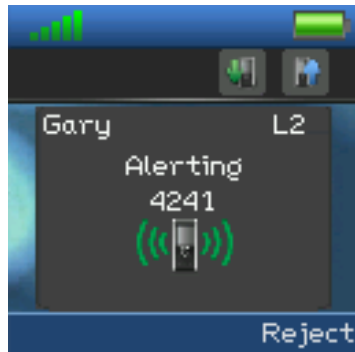

In this case the call waiting is from party 4241 (called Gary in the local phonebook).

It is possible to reject the call waiting with the "Reject" softkey and continue the ongoing call.

If the call party wants to answer the call waiting the off-hook key should be pressed. The following screen is displayed:

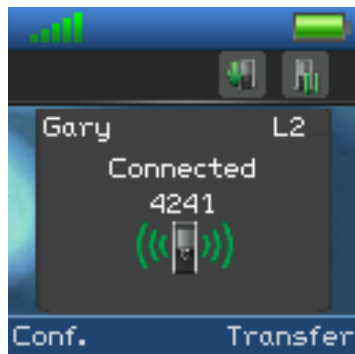

This indicates that the local handset now has two ongoing calls with one of them on hold, and it is possible to swap between them, make a conference, or transfer one of the parties.

CONFERENCE CALL

In a conference call there are always at least three parties in the same conversation. This feature enables the user to have an ongoing call with more than one person at the same time. The parties in a conference call are called participants.

ESTABLISHING A CONFERENCE CALL

This section describes how to establish a conference call between three parties.



1. Initiate a call with a party so that the handset displays “Connected” as shown above.
2. Press “Hold” to put the current call on hold.
3. The second party is put on hold.
4. Enter the number of the party that you want to invite to the conference and press the green “Off-hook” button  to call this participant.

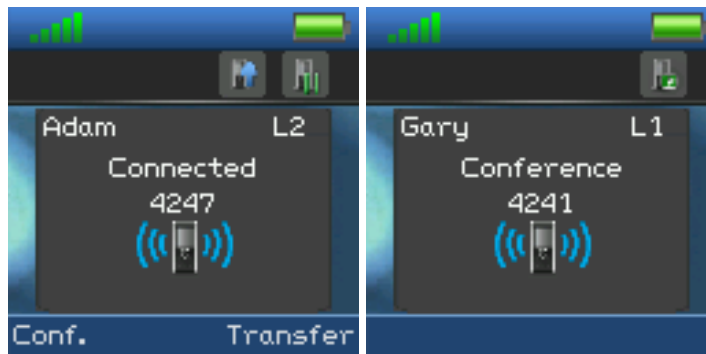

5. After the called party answers the call, the second party is still on hold and the conversation is only between the third party and the first party that is, the initiator of the conference.
6. Press the “Conf” softkey to form the conference.
7. The “Conference” screen as seen above is displayed and the three participants are in a conference call. Thereby the conversation is between all three parties.



Notes:

1. It is possible to invite more participants to the conference by repeating the steps 2-6 for one of the participants in the conference that has not yet invited a party to the conference. Once a participant has invited a new party to the conference it is not possible for this participant to invite additional parties into the conference.

TERMINATING A CONFERENCE CALL

When a conference call is terminated, the resulting behavior depends on which participant terminates the conference,

Option 1

- If the originator of the conference presses the red “On-hook” key  to terminate the conference call, none of the participants remain on the call.

Option 2

- If one of the invited participants in the conference presses the red “On-hook” key , that participant is dropped from the call. An ongoing call remains between the initiator of conference, and the other participant.



Note: Different configurations on the PBX that the base system uses may result in different terminations of a conference call.

TROUBLESHOOTING

This troubleshooting section contains information on how to solve some operational problems that you may experience on the handset.

OPERATIONAL PROBLEMS

State: The handset does not ring

Problem cause: The sound off icon is seen in the status bar; hence, the handset is silent mode.

Action: Increase the volume in Audio Settings, or long-press the # key in idle.



Note: If the Audio Settings is greyed out and cannot be changed, it is because the silent mode is enabled by long-pressing the #-key. Please, long-press the # key in idle to disable this silent mode.

State: The handset does not respond when pressing on the keys

Problem cause: Keylock feature is enabled, and a “Press and hold *” screen is displayed when pressing any key.

Action: Long-press (press for more than 2 seconds) the * key.

State: The handset shows “Searching” in the display

Problem cause: The handset is out of the coverage area of the base station system.

Action: Please move the handset back in coverage of the base system.



mitel.com

© Copyright 2015, Mitel Networks Corporation. All Rights Reserved.
The Mitel word and logo are trademarks of Mitel Networks Corporation.
Any reference to third party trademarks are for reference only and Mitel makes no representation of the ownership of these marks.